

VULCAN

INSTALLATION & OPERATION MANUAL

ELECTRIC COMBI, CONVECTION & STEAM OVENS

MODEL

<i>VCE6H</i>	<i>ML-126177</i>
<i>VCE10H</i>	<i>ML-126178</i>
<i>VCE10F</i>	<i>ML-126179</i>
<i>VCE20H</i>	<i>ML-126172</i>
<i>VCE20F</i>	<i>ML-126173</i>



For additional information on Vulcan-Hart or to locate an authorized parts and service provider in your area, visit our website at www.vulcanhart.com

TABLE OF CONTENTS

GENERAL	3
INSTALLATION.....	3
UNPACKING	3
LOCATION	3
STACKING KITS	3
LEGS OR CASTERS	4
LEVELING	4
CONDENSATE DRIP PAN	4
PLUMBING CONNECTIONS	5
WATER REQUIREMENTS	5
WATER SUPPLY CONNECTIONS	5
DRAIN CONNECTION	5
ELECTRICAL CONNECTION	6
VENT HOOD	6
BEFORE FIRST USE	6
OPERATION	7
DOOR OPENING AND CLOSING	7
GREASE FILTER	7
LOADING THE OVEN	8
UNLOADING THE OVEN	9
BUZZER	9
COOL DOWN	9
PROGRAMMABLE CONTROLS	10
PROBE	12
COOKING WITH THE PROBE	12
USING THE TEMPERATURE PROBE	12
TEMPERATURE PROBE APPLICATIONS	13
ENTERING A COOKING PROGRAM	13
PROGRAMMING MEMORY	14
RECALLING A PROGRAM FROM MEMORY	15
BAKING (CONVECTION BAKING - HOT AIR)	16
CONVECTION BAKING APPLICATIONS	17
STEAMING	18
STEAMING APPLICATIONS	19
COMBI (CONVECTION BAKING WITH STEAMING)	20
COMBI APPLICATIONS	21
COOK AND HOLD	22
COOK AND HOLD APPLICATIONS	23
EXAMPLE PROGRAM	24
MENU CARD	25
DELUXE MANUAL CONTROL	28
ENTERING A MANUAL COOKING OPERATION	29
STANDARD MANUAL CONTROL	30
ENTERING A MANUAL COOKING OPERATION	31
CLEANING	32
DAILY CLEANING	32
COMPLETE CLEANING	32
MAINTENANCE	34
CLEAN CYCLE DELIMING PROCEDURE	34
CONFIGURATION MODE — PROGRAMMABLE CONTROL	36
CONFIGURATION MODE — MANUAL CONTROL	38
TROUBLESHOOTING	40
SERVICE ADJUSTMENTS	40
SERVICE AND PARTS INFORMATION	40

Installation, Operation, and Care of ELECTRIC COMBI, CONVECTION & STEAM OVENS

SAVE THESE INSTRUCTIONS

GENERAL

The Electric Combi, Convection & Steam Ovens are single compartment ovens that provide convection heating and/or steaming in the cooking chamber. Humidification can be provided by the internal steam generator or by water injection (water vaporizes on contact with the hot oven interior).

The **Vulcan Combi Electric** ovens are sized **6**, **10**, or **20** levels high. The 6 level ovens are **Half** depth only. The 10 and 20 level ovens are either **Full** or **Half** depth. All models include one of the three controls: Manual Standard, Manual Deluxe, or Programmable. The **bold** numbers and letters explain the model-number conventions.

The 6 or 10 high ovens can be installed on a suitable countertop using the legs (standard) or on an accessory Stand. The accessory Stand may be equipped with an accessory Pan Slide which provides rack or pan storage underneath the oven. On 6 or 10 level ovens, the accessory Landing Table can load or unload all Racks in one motion when the oven is mounted on the accessory stand or on a countertop at the proper elevation. Additional Pan Racks and Racks are also available accessories. The 20 level ovens can be installed with legs or with accessory casters. Accessory 20 Level Half and 20 Level Full Trolleys allow loading or unloading all racks in one motion (trolleys may be priced with ovens). An available Hose Spray accessory can be installed near the oven to facilitate easy cleaning.

INSTALLATION

UNPACKING

Immediately after unpacking the oven, check for possible shipping damage. If the oven is found to be damaged, save the packaging material and contact the carrier within 15 days of delivery.

Prior to installation, verify that the electrical service agrees with the specifications on the oven data plate.

LOCATION

Allow space for operating the oven. Do not obstruct the ventilation ports above the oven. To provide ventilation access, allow 4" clearance on the right side of the oven and 6" clearance at the rear. A suitable amount of space should be provided for machine operation, cleaning, and service.

STACKING KITS

Stacking kits are available to allow ovens to stack, one on top of the other (available for 6 and 10 level ovens only). The bottom oven must be larger or the same size as the upper oven. Assembly Instructions are included with the kit.

LEGS OR CASTERS

WARNING: THE OVEN MUST BE BLOCKED AND STABLE BEFORE INSTALLING LEGS OR CASTERS.

Raise up and block the oven a minimum of 10" from the floor. Threaded holes are provided at the four corners underneath the oven; screw the threaded stud of the four legs or optional casters into the threaded holes. Four flanged legs allow anchoring to the floor (anchoring hardware not provided). Casters with brake should be installed at front, casters without brake, at rear.

Available Installation Accessories

Model	Legs* or Casters	Stand with Legs* or Casters	Stacking Kit with Legs* or Casters
VCE6H	Legs	Stand with Legs	Stacking Kit with Legs
		Stand with Casters	Stacking Kit with Casters
VCE10H	Legs	Stand with Legs	Stacking Kit with Legs
		Stand with Casters	Stacking Kit with Casters
VCE10F	Legs	Stand with Legs	Stacking Kit with Legs
		Stand with Casters	Stacking Kit with Casters
VCE20H	Legs		
	Casters		
VCE20F	Legs		
	Casters		

* Leg height will vary with application.

Use legs or casters on an oven if setting on floor. To provide common mating heights with trolleys, the 20 level half depth ovens use 7¹/₄" legs or casters while the 20 level full depth ovens use 8⁵/₈" legs or casters. Use legs only on an oven setting on a counter. Use legs or casters on stand if oven will sit on stand. Use legs or casters on bottom oven with stacking kit.

Castors may be used on an oven setting on the floor (not on an oven setting on a countertop). Castors may be used on an accessory stand or on the bottom oven with an accessory stacking kit. Caster equipped units should be installed with flexible plumbing and electrical connections to allow the unit(s) to be pulled out for cleaning or servicing. When moving the oven, the operator should not exceed the limitations of any flexible connections.

LEVELING

Caster equipped ovens must be placed on a level floor.

For ovens with legs, use a spirit level or pan of water in the bottom of the oven to make sure the oven is level, both front-to-back and side-to-side. Adjust the leveling feet on the bottom of the legs by turning the feet in or out to level the oven. After the drain is connected, check for level by pouring water onto the floor of the compartment. All water should drain through the drain opening.

CONDENSATE DRIP PAN

Remove screws under front of oven base and assemble condensate drip pan to bottom of oven (Fig. 2) using the thumb screws supplied loose with the oven. Condensate drip pan is incorporated with front cover of Stacking Kit accessory for the upper oven only. The lower oven of a stacked pair uses the standard condensate drip pan. The 20 level oven has a three-segment condensate gutter.

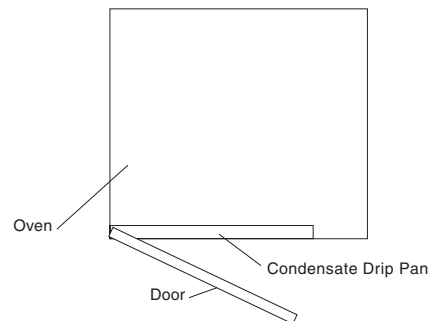

Fig. 1

PLUMBING CONNECTIONS

WARNING: PLUMBING CONNECTIONS MUST COMPLY WITH APPLICABLE SANITARY, SAFETY AND PLUMBING CODES.

Water Requirements

Proper water quality can improve the taste of the food prepared in the steamer, reduce liming in the steam generator and extend equipment life. Local water conditions vary from one location to another. Ask your municipal water supplier for details about your local water supply prior to installation.

WATER REQUIREMENTS

Supply Pressure	20 — 60 psig
Hardness*	less than 3 grains
Silica	less than 13 ppm
Total Chlorine	less than 4.0 ppm
pH range	7 — 8
Undissolved Solids	less than 5 microns
* 17.1 ppm = 1 grain of hardness	

Presence of sediment, silica, excess chlorides or other dissolved solids may lead to a recommendation for alternate form(s) of water treatment. Test the water with the test strip included with the combi oven. Other factors affecting steam generation are iron content, amount of chloridation and dissolved gases. A local water treatment specialist should be consulted before installation of steam generating equipment.

Water Supply Connections (Fig. 2)

A water filter system is recommended for the water supply line going to the treated water inlet of your oven. Follow the recommendations for use and installation instructions shipped with the water filter. If a water filter is not installed, the oven warranty may be limited.

Connect treated potable water (hot or cold) to the inlet labeled for treated water to supply the steam generator tank and humidifier. Untreated water contains scale producing minerals which, if supplied to the steam generator, can precipitate onto the surfaces in the steam generator tank. Due to the temperatures in the tank, the minerals can bake onto the surfaces and components. This can result in early component failure and reduced product life. Sensors in the steam generator tank use ions in the water to detect the water level. Do not use distilled (fully demineralized or de-ionized) water as this could provide a false reading to the sensors.

Connect untreated potable water (must be cold) to the inlet labeled for untreated water to supply the condenser which cools the drain water.

Both external-threaded nylon inlets $\frac{3}{4}$ " hose bibb ($\frac{3}{4}$ " NSHT, National Straight Hose Thread) are located at the rear of the oven. The nylon threads should be treated carefully so the connections do not leak. A manual shutoff valve should be provided, convenient to the oven, for each water supply line; both of these valves should be open when the oven is in operation. Water pressure for both incoming water lines should be between 20 and 80 psig.

Refer also to CLEAN CYCLE DELIMING PROCEDURE, pages 34 – 35.

Water Supply Inlets . . .
at Bottom Rear Corner of Oven
. . . Model VCE6H Shown.

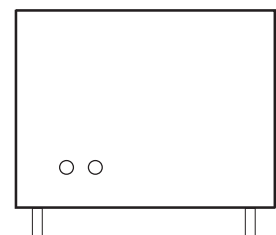

Fig. 2

Drain Connection

CAUTION: In order to avoid any back pressure in the oven, do not connect solidly to any drain.

Extend the drain line from the $1\frac{1}{2}$ " NPT drain pipe extending from the bottom of the oven at the rear to an open gap-type drain. Drain piping must have suitable pitch, have appropriate support along its length, and have no connection to other piping. The material used in the drain line should be heat resistant to at least 212°F.

ELECTRICAL CONNECTION

WARNING: ELECTRICAL AND GROUNDING CONNECTIONS MUST COMPLY WITH APPLICABLE PORTIONS OF THE NATIONAL ELECTRICAL CODE AND/OR OTHER LOCAL ELECTRICAL CODES.

WARNING: DISCONNECT THE ELECTRICAL POWER SUPPLY FROM THE OVEN AND FOLLOW LOCKOUT / TAGOUT PROCEDURES.

The wiring diagram is located on the inside surface of the right side panel as you face the oven. Use copper wire rated for at least 90°C for the connection.

ELECTRICAL DATA

Model	Volts / Hz / Ph	BRANCH CIRCUIT SIZE AND PROTECTION
		Minimum Circuit Ampacity Maximum Protective Device AMPS
VCE6H	208 / 60 / 3	35
	240 / 60 / 3	30
	480 / 60 / 3	15
VCE10H VCE10F	208 / 60 / 3	70
	240 / 60 / 3	60
	480 / 60 / 3	30
VCE20H	208 / 60 / 3	90
	240 / 60 / 3	80
	480 / 60 / 3	40
VCE20F	208 / 60 / 3	125
	240 / 60 / 3	110
	480 / 60 / 3	60

Compiled in accordance with the National Electrical Code, ANSI/NFPA 70, latest edition.

NOTE: Only single-phase fan motors are used on these ovens so there is no need to check direction of motor rotation. The fan will rotate in the proper direction.

VENT HOOD

Some local codes may require the Combi oven to be located under an exhaust hood. Information on the construction and installation of ventilating hoods may be obtained from *Vapor Removal from Cooking Equipment*, NFPA standard No. 96 (latest edition).

BEFORE FIRST USE

Before using the oven for the first time, it must be "burned in" to release any odors that might result from heating the new surfaces in the oven. Operate the oven at 480°F for 45 minutes in Convection Hot Air Mode. Depending on which control is furnished, perform CONFIGURATION MODE — PROGRAMMABLE CONTROL on pages 36 – 37 or CONFIGURATION MODE — MANUAL CONTROL on pages 38 – 39.

OPERATION

WARNING: THE OVEN AND ITS PARTS ARE HOT. USE CARE WHEN OPERATING, CLEANING OR SERVICING THE OVEN. THE COOKING COMPARTMENT CONTAINS LIVE STEAM. STAY CLEAR WHEN OPENING DOOR.

DOOR OPENING AND CLOSING

The oven door is equipped with an electrically powered lock. The oven is delivered with the door latched and slightly open (Fig. 3) and can be opened by firmly pulling the door handle (Fig. 5). Push the door until it connects with the latch but remains slightly open (Fig. 3). This is the position the door should be in when the oven is not in use. The door should also be in this position after cooking to allow steam to escape before fully opening the door. Push the handle until it is in line with the oven door. If power has been connected, the door will now lock automatically, sealing the oven chamber (Fig. 4).

To release the door, rotate (pull) the handle 90 degrees. The door automatically releases to the 'latched and slightly opened' position. Allow a few seconds for steam to escape before pulling the door open (Fig. 5).

NOTE: On Programmable Controls if the ON button is pushed after the oven is turned on, the door will be latched but slightly open (Fig. 3) for three seconds; the handle can be released by rotating 90 degrees as shown in Fig. 5. If the handle is not released within the three second interval, the door will automatically re-close. A separate Door Open button will perform the same function with Manual Standard or Deluxe Controls.

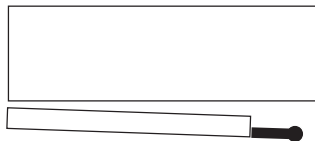

Fig. 3

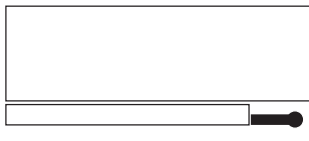

Fig. 4

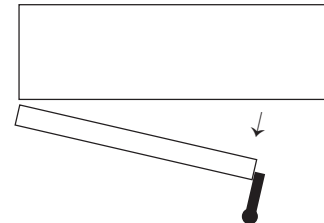

Fig. 5

NOTE: In the event of a power failure, the door may be opened by pulling the handle firmly towards you while firmly pressing against the front of the oven with the other hand (avoid hot air contact).

GREASE FILTER

The grease filter in the rear of the oven chamber should be in place when roasting meat items but may be removed before baking items that do not produce grease-laden vapors. See Cleaning, page 32, for information on how to remove the grease filter.

LOADING THE OVEN

Open the door. Place the product to be cooked in suitable containers and slide into the racks or place the containers securely on shelves in the oven.

When loading a 6 or 10 level oven with the landing table (Fig. 6), the bottom frame of the rack should be secured by the rotary lock. Move the loaded landing table to the front of the open oven; secure the landing table to the oven by actuating the locking-clamp (or use your body to hold the landing table against the oven). Rotate the lock-knob to release the pan rack and carefully roll the loaded pan rack into the oven, making sure that the landing table does not separate from the oven during the transfer.

NOTE: When the landing table is not in use on the 6 or 10 level oven, make sure the rack retainer (delivered with the oven) is fitted under the fan baffle to prevent the pan rack from tilting when pans are being removed.

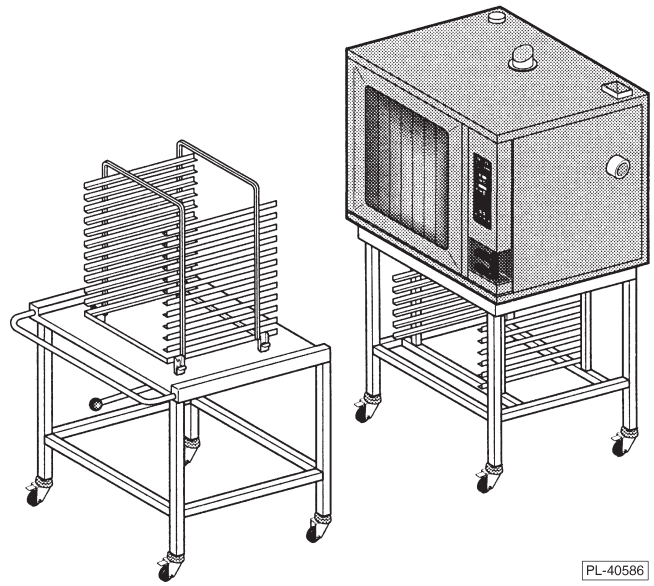

PL-40586

Fig. 6

When loading a 20 level oven with the trolley (Fig. 7), make sure the handle is locked in the down position so the rack is held securely to the trolley with its lifting hooks. Carefully move the loaded trolley completely into the open oven. When the rear frame of the rack is positioned behind the edge of the retainer, raise the handle to lower the rack-frame to the oven door.

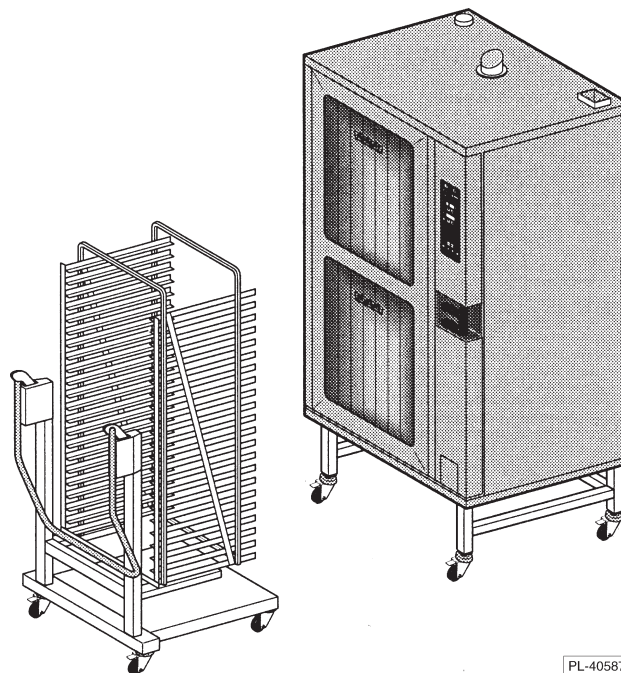

PL-40587

Fig. 7

UNLOADING THE OVEN

Allow the door to be 'slightly-opened' for a few seconds to allow hot air and steam to escape. Stand behind the door while opening.

When unloading a 6 or 10 level oven, move the landing table so the clamp locks the landing table to the front of the oven (or use your body to hold the landing table against the oven). Remove the landing table handles and clamp them to the bottom of the hot oven pan rack. Carefully roll the hot pan rack onto the landing table platform, making sure that the landing table does not separate from the oven during transfer. Rotate the knob to allow the rack to move completely to the front of the landing table; and rotate the knob back to lock the pan rack in place.

When unloading a 20 level oven, move the trolley (Fig. 7) into the oven until the "lift-hooks" are inserted into both sides of the front frame of the rack in the correct "lift" position. Lower the trolley handle until it stops; the loaded rack is lifted from its retainer and held securely to the trolley by the "lift-hooks". The trolley may now be removed from the oven with the loaded rack securely held in place.

BUZZER

When either the Cooking Time has elapsed or the final internal Probe Temperature has been reached, the buzzer will sound [ON for 15 seconds and OFF for 45 seconds] until Start / Stop, , is pressed. If done, the product should be removed, portioned, and served. The Buzzer can be adjusted two ways: Buzzer loudness can be adjusted by your service technician. Buzzer frequency can be set in configuration mode (page 36 or 38, depending on which control is furnished).



COOL DOWN

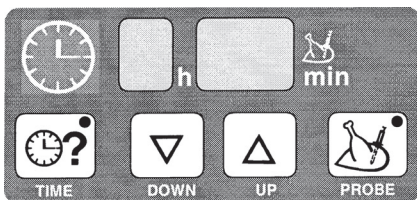

With either Programmable or Manual Controls, when the cooking phase is changed from a higher temperature in Hot Air or Combi Modes to Steam Mode, the Humidifier discharges automatically. This produces steam, opens the oven vent, and lowers the oven temperature to 212°F.

When empty after a cooking process has been completed, the oven may be too hot for the next operation. The oven can use the Humidifier to cool itself. With Programmable Controls, Cool Down can be programmed as one of the five Cooking Phases. To perform a Cool Down with Programmable Controls, follow this procedure:



Press Start / Stop, , to stop operation.

Press the down arrow key until the timer is clear,  h  min .

Press the down arrow until the rain symbol displays,  h  min .

The temperature is set at 158°F but can be further lowered to as low as 86°F.

Press Start / Stop, , to start operation.

The Humidifier will continue to discharge until 158°F or other set temperature is reached.

Buzzer sounds. Press Start / Stop, , to silence buzzer.

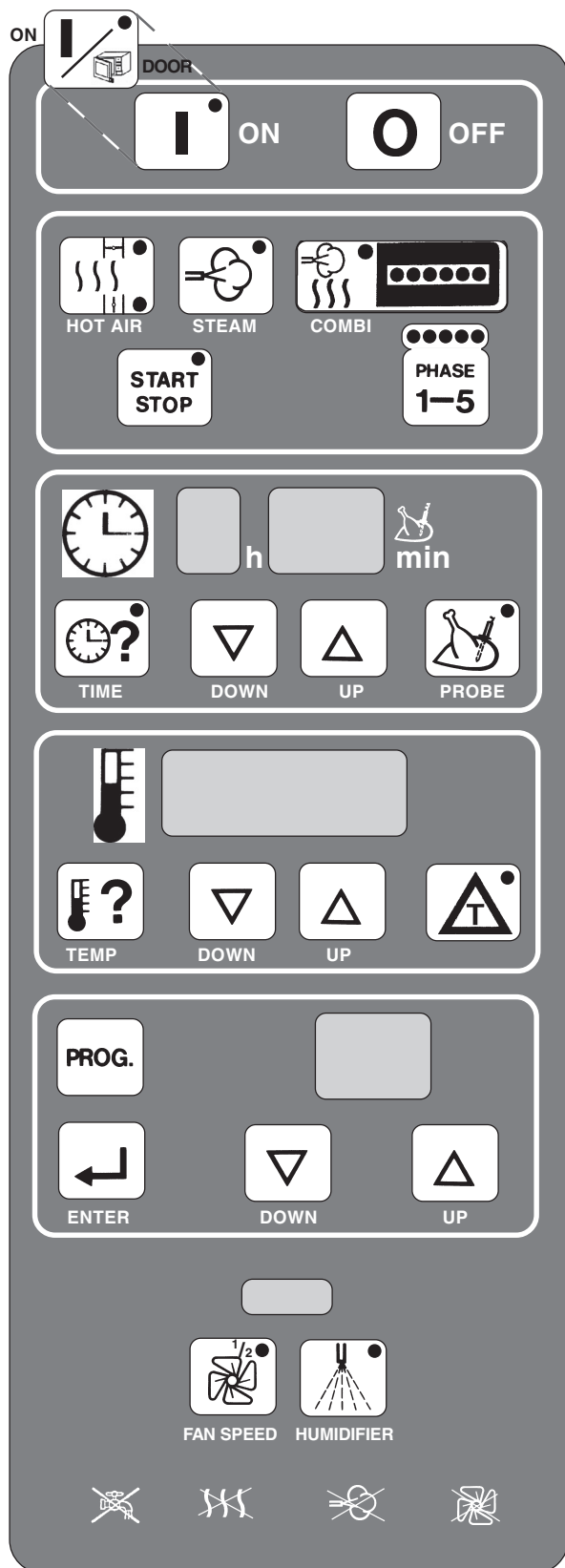

NOTE: With Programmable Controls, the Humidifier button can be used at any time to make steam and lower the temperature.

PROGRAMMABLE CONTROLS



ON OFF See Door Opening and Closing, page 7.

COOKING MODE

- HOT AIR (Convection Baking) also chooses VENT CLOSED  or VENT OPEN 
- STEAM
- COMBI (Convection & Steam)

START ~ STOP PHASE 1 – 5

COOKING TIME or PROBE TEMPERATURE

- SET Cooking Time
- DISPLAY Cooking Time, remaining
- SET Probe Temperature, final
- DISPLAY Probe Temperature, actual

OVEN TEMPERATURE or

- SET Oven Temperature, desired
- DISPLAY Oven Temperature, actual
- SET  and use with Probe Temperature

PROGRAM NUMBER

- SET Cooking Programs
- RECALL or CHANGE a Cooking Program
- ENTER [] to save the Cooking Program

FAN SPEED ~ Full or Half Power

HUMIDIFIER, non-programmable (see Cool Down, p.9)

Trouble Indicator Lights:

Water Supply / Heat / Steam / Fan

- ON** — After an initial power-up sequence, the control panel indicator lights and the light inside the oven are lit. The actual oven temperature is shown in the Temperature display, – h – – min is in the Time display, and – – is in the Program Number display. The control will now accept commands. The ON button also cancels a manual cooking operation of up to 5 Phases. • Open the water supply valve. See page 7.
- OFF** — Shuts off the oven and oven light, opens the oven vent, and drains the steam generator tank (pump takes about a minute). • Close the water supply valve.

COOKING MODE

- HOT AIR** — Heat and Fan are ON; steam generator tank fills. Initial temperature setting is 302°F (range is 35 – 518°F). Push  once for Vent Closed, |H|; twice for Vent Open, |H||.
- STEAM** — Steam and Fan are ON; steam generator tank fills, if not already full. Initial temperature setting is 212°F (range is 35 – 212°F).
- COMBI** — Heat, Fan, and Steam are ON; steam generator tank fills, if not already full. Initial temperature setting is 302°F (range is 35 – 518°F). The amount of steaming is set by the number of times you press the Combi key (1 – 6), indicated by the row of lights.









START STOP — Starts or stops a cooking operation. Temperature flashes if door is not locked.

PHASE 1–5 — Indicates the Phase of a cooking program. Allows you to step through and display the cooking information for each phase of a cooking operation before starting.

COOKING TIME or PROBE TEMPERATURE

- TIME** — Displays the Cooking Time. Time remaining for ALL phases is normally displayed. Press the Time key again to display the time remaining for the current phase. When - - displays in the time display, the oven is in manual mode (no switch off at end).
- DOWN** — Decreases the Cooking Time or Probe Temperature setting.
- UP** — Increases the Cooking Time or Probe Temperature setting.
- PROBE** — Displays the Probe Temperature setting, initially 140°F, (range 70 – 210°F). After 5 seconds, displays the actual Probe Temperature.

OVEN TEMPERATURE or

- TEMP** — Displays the Oven Temp instead of . Normally displays the actual Oven Temp. Press Temp to display the Oven Temperature setting for 5 seconds and adjust it.
- DOWN** — Decreases the Oven Temperature or  setting.
- UP** — Increases the Oven Temperature or  setting.
-  — Displays  instead of Oven Temperature (temperature difference is indicated by __t in the display).  keeps the oven  degrees warmer than the actual Probe Temperature.  must be used with the Probe Temperature.

PROGRAM NUMBER

- PROG.** — Recalls and displays the cooking programs, by number, beginning with 00.
- DOWN** — Decreases the Program Number (range is 00 – 98).
- UP** — Increases the Program Number (range is 00 – 98).
- ENTER** — Stores the cooking parameters (up to 5 Phases) in memory under the Program Number. Cooking parameters will not be lost during power outage or disconnection.

FAN SPEED — Push once for Half Speed (light is on); push twice for Full Speed (light is off).

HUMIDIFIER — Sprays a little water into the oven while button is pushed. Makes steam if oven is hot.

PROBE

The Probe Temperature defines the final temperature of the product for any cooking phase. The cooking cycle stops when the product temperature reaches the probe temperature setting. Total Cooking Time is not known or entered when using the probe.

COOKING WITH THE PROBE

There are two ways to control the oven temperature when using the Probe . . .

- 1) Setting the Oven Temperature at a constant value. The oven climbs to the set point and the product cooks at that temperature. The cooking cycle ends when the product reaches the Probe temperature setting. Or,
- 2) Using ΔT , the Oven temperature gradually increases as the internal temperature of the product increases, always maintaining the oven at ΔT degrees warmer than the product. ΔT can provide a slow cooking process that allows the product's required final internal temperature to be reached without over-browning the outside of the product. The Probe Temperature (not cooking Time must be used when using ΔT . For Hot Air or Combi Modes, the recommended minimum ΔT is 110 F°; maximum is 240 F°. For Steam Mode, the recommended minimum ΔT is 60 F°; maximum is 180 F°.

The graph, below, shows two ways of controlling the oven temperature when using the Probe. The 150 F° value for ΔT is used to show how the oven works and is not typical of any particular cooking program.

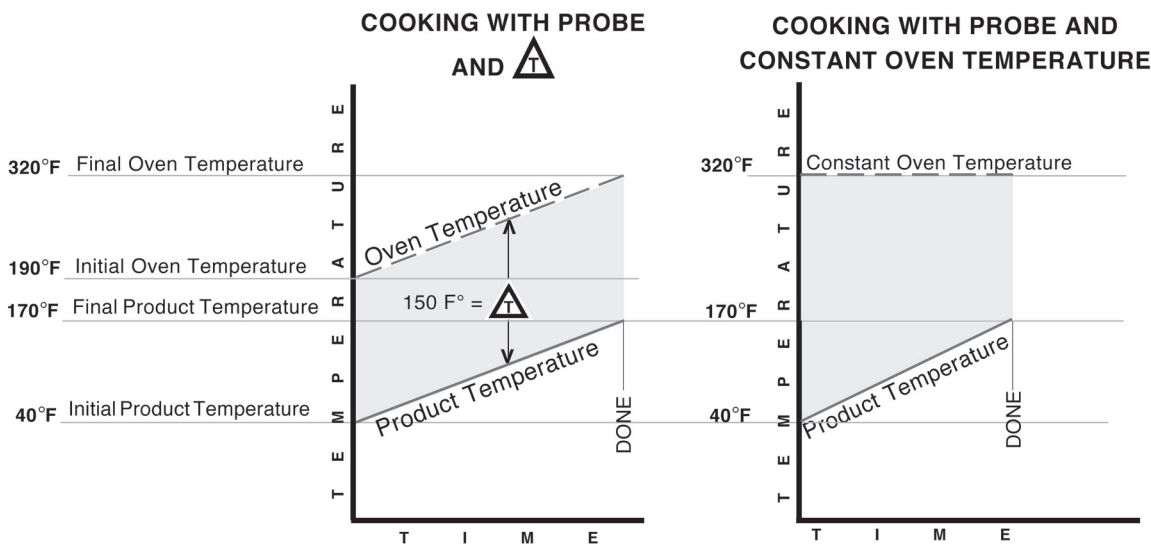

USING THE TEMPERATURE PROBE

The Temperature Probe is kept in a metal holder at the top of the oven when not in use. Remove the probe from its holder; the cable remains permanently connected to the top of the oven. Insert the pointed end of the probe so its tip is approximately in the middle of the product to be cooked. The probe cable is long enough to allow the product to be placed on one of the upper racks in the oven. The probe can be used to define the final temperature for any phase of the cooking process and for any of the three cooking modes: Convection (Hot Air), Steam, or Combi.

- To set the Probe Temperature, press  and use the UP and DOWN arrows to adjust the setting. The Cooking Time cannot be used when the Probe Temperature is in use.

NOTE: During Operator training to demonstrate use of the probe, place the probe in a container of water to simulate cooking of actual product.

TEMPERATURE PROBE APPLICATIONS

All Applications are suggested only — prove your own recipes and temperature / time settings.

Product	Recommended Final Probe Temperature °F
Beef Rare Medium Well Done	140 160 170
Lamb	175 – 185
Pork Fresh Smoked	170 140 – 170
Turkey Whole Boneless	185 170
Veal	170

ENTERING A COOKING PROGRAM



1. When entering cooking parameters, always select the **Mode** as the first element in a cooking phase: HOT AIR, STEAM, or COMBI (also, select Vent Closed or Open for HOT AIR mode and Steam Factor for COMBI mode).
2. Enter the finish parameter for the cooking phase (COOKING TIME or PROBE TEMP.) with its value.
3. Enter the oven control parameter for the cooking phase (TEMP or) with its value. FAN Speed can be set at FULL or 1/2.
4. Steps 1, 2, and 3 complete the parameters for that phase. For any additional phase (or phases), press the PHASE 1 – 5 key. Repeat steps 1, 2, 3, and 4 for each cooking phase.
5. If programming a repeat cooking process, select a Program Number following the instructions for Programming Memory on the next two pages.
6. Press to start cooking; the indicator light in the Start Stop key indicates the oven is operational.
7. When finished, press again, to silence the buzzer.

PROGRAMMING MEMORY

Up to 99 Cooking Programs with up to 5 Phases in each program can be keyed-in and stored in Memory. Each program is accessed by its identifying number. Program numbers range from 00 – 98. A pre-defined Clean Cycle Delimiting program is also available, see page 34.

If the numbered Program has not been programmed (or is vacant), the Time displays – h – – min. No Mode or Phase indicator lights are lit. The Temperature displays – – or the current temperature.

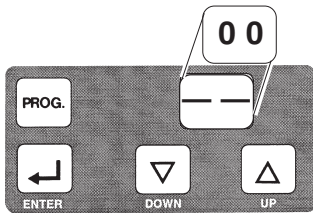

To **CREATE** a new program —



With — — in the program number display, the control is in Manual mode.

Press the **PROG.** key. Program Number 00 is displayed and the control is in Program Mode. Use UP or DOWN arrows to increase or decrease the program number until a vacant program number is found.

ENTER THE COOKING INSTRUCTIONS (FOLLOW STEPS 1 – 6):

- 1) Select the cooking mode: Hot Air, Steam, or Combi.
If Hot Air, select Vent (Closed or Open).
If Combi, set Steam Factor.
- 2) Set either the Time or Probe Temperature.
- 3) Set the Oven Temperature or . Select Fan 1/2 speed or full.
- 4) End of the 1st Phase. Press  to shift to the next phase.
- 5) Repeat steps 1 – 4 for as many of the 5 phases as are needed. Review the program by stepping through the phases. Make any needed changes.
- 6) When the program is set, save it in memory by pressing  until the beep is heard.

NOTE: A cooking program can also be entered in manual mode and saved to a program number by selecting the Program Number and pressing  for about three seconds.

To **DELETE** an existing program —

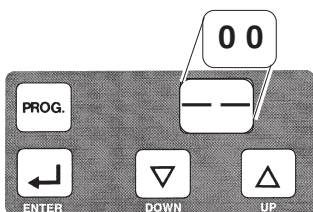

With — — in the program number display, the control is in Manual mode.

Press the **PROG.** key. Program Number 00 is displayed and the control is in Program Mode. Use UP or DOWN arrows to increase or decrease the program number until the program number to be deleted is displayed.

Press  and hold it in for about three seconds until the beep sounds, indicating the program has been deleted.

NOTE: If a previous program had been selected and was active in manual mode, it will be copied to the selected program number, replacing the previous program. Verify that the program number is vacant after you delete it.

To **COPY** an existing program to a *NEW* program number —

Recall and display the program number that you wish to copy.

Press  to begin the program. Pause. Press  to stop the program.

Change the program number to the *NEW* number.

Press  until the beep sounds, indicating the program has been copied.

To **CHANGE** a program —

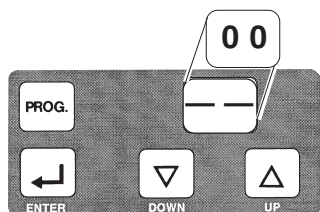

With — — in the program number display, the control is in Manual mode.

Press the  key. Program number 00 is displayed. Use the UP or DOWN arrows to increase or decrease until the program number you want to change is displayed.

Step through each phase, making any temperature, time or other changes for the phase; press  to shift to the next phase. The program number begins to blink when one or more changes have been made to the program.

To **SAVE** the changed cooking program, press  and hold it in for about three seconds until the beep sounds.

RECALLING A PROGRAM FROM MEMORY

Once a menu item has been programmed, it can be recalled, reviewed and used to cook food.

If the Program has already been programmed, its values are recalled from memory and displayed. You can view all the programmed information by stepping through the phases using the phase button.

To **RECALL** a program from memory —

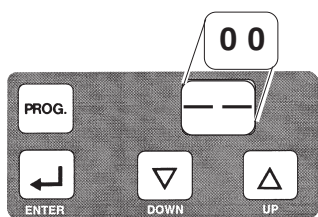



With — — in the program number display, the control is in Manual mode.

Press the  key. Program Number 00 is displayed. Use the UP or DOWN arrows to select the program number you want.

Use the Phase 1 – 5 key to step-through and verify the cooking parameters for each phase of the cooking program.

Load the oven. If using the probe, place it in the center of the product.





Close the door and press  to begin the cooking program. The blinking indicator light in the Phase 1 – 5 key shows which phase of the cooking program is being performed. If the program is timed, the display shows the total time remaining. When the cooking program is done, the buzzer will sound.

Press  to silence the buzzer. Check the product for doneness.

BAKING (Convection Baking – HOT AIR)

Convection Baking involves baking, browning, roasting, etc. without adding steam or moisture to the process. Hot air is fan-circulated to maintain even temperatures throughout the oven. Preheating the oven before loading the product is recommended.

Automatic Convection Baking can be set up so the buzzer sounds when the Cooking Time has elapsed or when the product's internal temperature has reached the Probe Temperature set point. If using the Probe Temperature, insert the probe near the center of the product. Cooking Time is not used when the Probe Temperature is in use.

If using the Probe Temperature, either the Oven Temperature or  can be used to control the oven during baking. If using the Oven Temperature setting, the oven temperature will remain constant throughout the convection baking operation or phase. If using the Probe Temperature,  can be set to keep the oven temperature  degrees warmer than the Probe. With  cooking, the oven temperature gradually increases at the same rate as the internal temperature of the product, always maintaining a constant difference. The result with  is slow baking or roasting with less brown crusting on the outside of the product.





Turn the oven ON.



Select Convection (HOT AIR) Mode; and set the Vent Closed or Open.



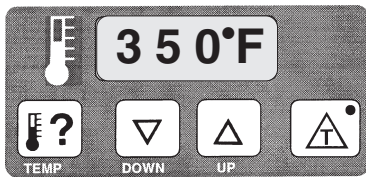

For *standard automatic* baking, set the Cooking Time and Oven Temp.

- To set the Cooking Time, press  and use the UP and DOWN arrows to adjust the setting.
- To set the Oven Temperature, press  and use the UP and DOWN arrows.





For *final product temperature* baking, set the Probe Temperature.

- To set the Probe Temperature, press  and use the UP and DOWN arrows. When the Probe Temperature indicator is lit, the numeric value in the time display is the Probe Temperature in °F. Probe Temperature can be used with either  or .



For *slow baking or roasting*, use  with the final Probe Temperature.

- To set , press  and use the UP and DOWN arrows.

When the control is set, load the oven. If using the probe, place it in the center of the product. Close the door and press  to begin.

Upon completion of the baking process, when either the Cooking Time has counted down or the Probe Temperature has been reached, the buzzer will sound.

Press  to silence the buzzer. Check the product for doneness.

CONVECTION BAKING APPLICATIONS – HOT AIR MODE

All Applications are suggested only — prove your own recipes and temperature / time settings.

Product	Preparation	Preheat Temp (°F)	Oven Temp (°F)	Time (minutes)
FISH				
Cod or Mullet, fresh	Season, Oil	390	350	10 - 12
Sea-frozen fish fillet	Thoroughly oil plate bottom and upper side of fish fillet. After baking, let stand for 2 minutes to avoid sticking and make portioning easier.	480	350	10 - 12
Sole, fresh	Season, Oil	425	350	10 - 12
Trout, fresh	Season, Oil	425	350	10 - 12
Trout, frozen	Season, Oil	425	350	15 - 22
Trout, breaded, fresh	Dip in flour, egg, breadcrumb mixture Grease pan thoroughly	480	435	15 - 20
PORK				
Pork Chop, fresh, sauteed	Season, Oil lightly	480	350	10 - 12
Pork Chop, frozen, sauteed	Oil lightly; Season after roasting	480	425	15
Pork Cutlet, fresh 4 - 5 oz	Dip in egg, breadcrumb batter, thoroughly oil the breaded surface of the cutlets, avoid leaving dry spots, lightly oil plate bottom.	480	425	10 - 12
Pork Cutlet, fresh, breaded	Oil both sides	425	350	10 - 12
Pork Loin Cutlet, fresh 4 - 5 oz	Do not season	480	425	6 - 8
Ham Steak, fresh	Season, Oil lightly	480	350	6 - 10
Pork Sausage, fresh	Oil lightly	480	425	8 - 10
Pork Steak, fresh	Season, Oil lightly	500	480	7
Pork Steak, frozen	Oil, Season after roasting process	500	425	10 - 12

Product	Preheat Temp (°F)	Oven Temp (°F)	Time (minutes)
PASTRY			
Puff Pastry	340	340	18 - 20
Danish Pastry	350	350	18 - 20
Flaky Pastry	340 - 350	340 - 350	16 - 18
Cake	350	350	8
Fruit Cake	320	320	55 - 65
Yeast Rolls with milk	390	390	10 - 12
Almond Pastry	350	350	10 - 12
Nut Pastry	350	350	10 - 12
Chocolate Pastry	350	350	10 - 12
Biscuit Pastry	350	350	10 - 12

Recommended setting for  in Convection Baking Mode is a minimum of 110 F° (61 C°).

STEAMING (Steam Mode only)

Steam cooking is used for stewing, poaching, and gentle cooking of products cooked in water. Steam flows without pressure into the oven. The fan circulates the steam to all parts of the oven. Allow the steam generator to preheat for 4 - 5 minutes if starting from cold. Also, it is recommended that you preheat the oven using the Convection Baking (HOT AIR) Mode.

Automatic Steaming can be set up so the buzzer sounds when the Cooking Time has elapsed or when the product's internal temperature has reached the Probe Temperature set point. If using the Probe Temperature, insert the probe near the center of the product. Cooking Time is not used when the Probe Temperature is in use.

Usually, the Cooking Time and Oven Temperature are used to control the steaming process.

Alternatively, the Probe Temperature can be used to indicate when cooking is done. When using the Probe Temperature, either the Oven Temperature or  can be used to control the oven.





Turn the oven ON.



Select Steam Mode.



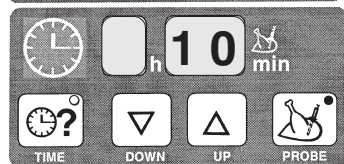

For *standard automatic* steaming, set the Cooking Time and the Oven Temperature.

- To set the Cooking Time, press  and use the UP and DOWN arrows.
- To set the Oven Temperature, press  and use the UP and DOWN arrows to adjust the setting.



For *final product temperature* steaming, set the Probe Temperature.

- To set the Probe Temperature, press  and use the UP and DOWN arrows. When the Probe Temperature indicator is lit, the numeric value in the time display is the Probe Temperature in °F. Probe Temperature can be used with either  or .



When the control is set, load the oven. If using the probe, place it in the center of the product.

Close the door and press  to begin.

Upon completion of the steaming process, when either the Cooking Time has counted down or the Probe Temperature has been reached, the buzzer will sound.

Press  to silence the buzzer. Check the product for doneness.

STEAMING APPLICATIONS

All Applications are suggested only — prove your own recipes and temperature / time settings.

Product	Preparation	Time (minutes)
VEGETABLES		
Asparagus, fresh	Sprinkle with lemon drops before cooking	12 - 15
Broccoli, fresh	Season after cooking	15 - 18
Brussels Sprouts, fresh or frozen	Season after cooking	15 - 18
Cabbage, white, sliced, fresh		15 - 18
Carrots, small, fresh or frozen	Season after cooking	18 - 20
Carrots, diced, fresh		15 - 18
Cauliflower, fresh or frozen	Season after cooking	15 - 18
Cauliflower, head, fresh	Sprinkle with lemon drops before cooking	18 - 20
Celery, slices or diced	Sprinkle with lemon drops before cooking	18 - 20
Corn, on-the-cob, fresh	Sprinkle with lemon drops before cooking	15 - 18
Eggplant		10
Green Beans, fresh or frozen	Season after cooking	18 - 20
Mushrooms, halved, quartered, or sliced	Sprinkle with lemon drops before cooking	8 - 10
Peas, frozen	Season after cooking	12 - 15
Potatoes	Soak in 10% salt water for 15 minutes before cooking; or, salt dry	30 - 35
Spinach, fresh		2 - 4
SIDE DISHES		
Dumplings, Meat Balls	Steam without added water	15 - 20
Pasta	Before cooking, cover with hot water and add some oil. Mix thoroughly once during the cooking process.	20 - 25
Rice	Add water to 150% of rice depth.	20 - 25
MEAT		
Brisket	Add seasoning and vegetables to the meat	90 - 120
Veal, fricassee	Add seasoning and vegetables to the meat	45 - 50
FISH & CRUSTACEANS		
Cod, Halibut, fresh or frozen	In serving size portions, 12 / pan	10 - 12
Crayfish Tails, frozen	Sprinkle with lemon drops and perhaps cover with fresh dill	12 - 15
Mussels	Add some wine	8 - 10
Salmon, fresh	Season with lemon	8 - 10

Recommended setting for  in Steam Mode is a minimum of 60 F° (33 C°).

COMBI (Convection Baking with Steaming)

Combi baking / steaming is used for baking, roasting, or braising when steam needs to be added to the oven during a convection baking operation. The 'Steam Factor' can be varied by repeat pressing of the Combi key — see Steam Factor in the table below. It is recommended that you preheat the oven.



Automatic Combi baking / steaming can be set up so the buzzer sounds when the Cooking Time has elapsed or when the product's internal temperature has reached the Probe Temperature set point. If using the Probe Temperature, insert the probe near the center of the product. Cooking Time is not used when the Probe Temperature is in use.

Usually, the Cooking Time and Oven Temperature are used to control the Combi baking / steaming process. Alternatively, the Probe Temperature can be used to indicate when cooking is done. When using the Probe Temperature, either the Oven Temperature or  can be used to control the oven.



Turn the oven ON.

Select Combi Mode and set the Steam Factor (see table below).*

For *standard automatic* Combi baking with steaming, set the Oven Temperature and the Cooking Time.

- To set the Cooking Time, press  and use the UP and DOWN arrows.
- To set the Oven Temperature, press  and use the UP and DOWN arrows to adjust the setting.

For *final probe temperature* Combi baking with steaming, set the Probe Temperature.

- To set the Probe Temperature, press  and use the UP and DOWN arrows. When the Probe Temperature indicator is lit, the numeric value in the time display is the Probe Temperature in °F. Probe Temperature can be used with either  or .

When the control is set, load the oven. If using the probe, place it in the center of the product. Close the door and press  to begin.

Upon completion of the Combi baking with steaming process, when either the Cooking Time has counted down or the Probe Temperature has been reached, the buzzer will sound.

Press  to silence the buzzer. Check the product for doneness.

* When selecting Steam Factor, press  1 to 6 times to obtain the desired steaming.

Indicator Lights	Combi Key	Steam Factor
○●●●●●	Press one time.	5
○○●●●●	Press two times.	10
○○○●●●	Press three times.	20
○○○○●●	Press four times.	30
○○○○○●	Press five times.	40
○○○○○○	Press six times.	50



COMBI APPLICATIONS

All Applications are suggested only — prove your own recipes and temperature / time settings. Combi applications typically begin with a Steam Mode phase which automatically preheats the steam generator in readiness for a subsequent Combi Mode phase. Some applications contain a HOT AIR or Convection Mode phase. Combi Mode is seldom performed as a single phase cooking operation.

Product	Preparation	Phase 1	Phase 2	Phase 3	Total Time (minutes)
BEEF					
Boned & Rolled Roast Beef	Season, oil, add carrots, leaks, onions, and red wine	Steam 90 minutes	Combi 60 minutes 250 - 280 ° F	—	150
Roast Beef	Season and oil lightly	Steam 20 minutes	Combi 15 minutes per pound 280 - 320 ° F	Convection 10 minutes 360 - 390 ° F	—
Roulades	Season, oil, and add red wine	Steam 30 minutes	Combi 40 minutes 280 - 320 ° F	—	70
Braised Beef		Steam 90 minutes	Combi 55 minutes 320 ° F	Convection 10 minutes 390 ° F	155
Meat Loaf 3 lb.	Oil lightly in pan	Steam 10 minutes	Combi Stm Factor 50 20 minutes 250 ° F	Convection 10 minutes 250 ° F	Final Internal Temperature 165° F
Stuffed Cabbage	Season, sprinkle with caraway and brown onions	Steam 45 minutes	Combi 20 minutes 350 ° F	—	65
Veal, Brisket, stuffed	Season, oil lightly	Steam 15 - 20 minutes	Combi 60 - 70 minutes 290 ° F	—	75 - 90
Veal, Roast Loin of	Season, oil lightly, add vegetables as basis of sauce	Steam 20 minutes	Combi 70 - 80 minutes 280 - 320 ° F	—	90 - 100
PORK					
Pork Loin, Boneless	Add red wine	Steam 10 minutes	Combi 30 - 40 minutes 280 - 320 ° F	—	40 - 50
Pork Pie or Meatloaf	Approximately 4 - 5 lb per aluminum pan	Steam 10 minutes	Combi 60 - 70 minutes 250 - 280 ° F	—	70 - 80
Pork Sausage, coarse		Steam 5 - 6 minutes	Combi 5 - 6 minutes 350 ° F	—	10 - 12
Pork Sausage, fine		Steam 5 minutes	Combi 5 - 7 minutes 390 ° F	—	10 - 12
Stuffed Peppers	Place with the opening on the bottom	Steam 40 - 45 minutes	Combi 15 minutes 340 ° F	—	55 - 60
POULTRY					
Chicken, 3 lb. whole	Season, Oil	Combi Stm Factor 30 15 minutes 325 ° F	Convection 18 minutes 400 ° F	Final Internal Temperature 175° F Inner Thigh	33
Turkey, 9 - 11 lb. whole	Season, Oil	Combi Stm Factor 40 80 minutes 275 ° F	Convection 30 minutes 325 ° F	Final Internal Temperature 175° F Inner Thigh	110

COOK AND HOLD

Cook and Hold is set up as a two-phase cooking process. The first phase is programmed similar to any other Convection, Steam, or Combi operation by selecting: 1) the mode 2) the finish cooking parameter (cooking time or probe temperature, with its value) and 3) the oven control parameter (oven temperature or , with its value).

During the second phase of the cooking process, the Oven Temperature is typically set at 140°F. Oven heat is allowed to dissipate slowly while the internal temperature of the product is still increasing. Select    for the Cooking Time to be on HOLD for the second phase. Select $\frac{1}{2}$ Fan Speed for the second phase of the cooking operation.

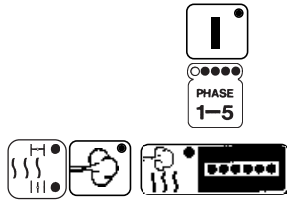





Turn the oven ON.

The phase indicator for the first phase is blinking.

Select the cooking mode for phase one: Hot Air, Steam, or Combi.

- In Hot Air mode, select Vent Closed or Vent Open.
- In Combi mode, set the Steam Factor.

Select the finish parameter for the first phase,  or  and enter its value using the UP and DOWN arrows.



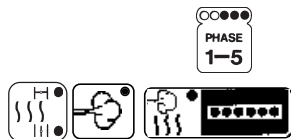

Select the oven control parameter for the first phase,  or  and its value.





Press the Phase key. The phase two indicator light should be blinking.

Select the cooking mode for phase two: Hot Air, Steam, or Combi.

- In Hot Air mode, select Vent Closed or Vent Open.
- In Combi mode, set the Steam Factor.

Press  and use the DOWN arrow (one step below 0) . . . until    displays in the time display for the second phase.

Press  and set the Hold Temperature at 140°F using the UP and DOWN arrows. Press  to set the fan at half speed during the second phase HOLD mode.

Load the oven. Insert the probe (optional). Close the door.

Press  to begin.

After completing the first phase, the oven temperature will decline to the 140°F HOLD temperature and will maintain that temperature with the fan at $\frac{1}{2}$ speed until the oven is shut off manually.

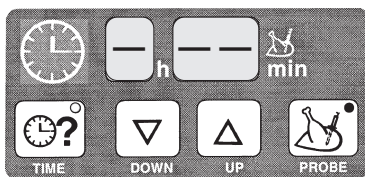

COOK AND HOLD APPLICATIONS

All Applications are suggested only — prove your own recipes and temperature / time settings.

This two-stage process cooks roast beef or other products slowly and efficiently. During the first phase, the oven cooks at the Oven Temperature for a set amount of time or until a Probe Temperature is reached. When the first phase is complete, the oven heaters turn off and fan is at half speed. The roast continues to cook as the temperature declines to the Hold Temperature, (140°F for beef). The heaters then resume at half power, maintaining the "ready-to-serve" or Hold Temperature indefinitely. After unloading, the oven can be used for its next cooking task or shut off manually.

Cook And Hold — Rolled Beef Roasts – Refrigerated, Not Frozen						
Oven Temp °F	200 °F		250 °F		300 °F	
Doneness Final Internal Temp °F	Rare 140 °F	Med 160 °F	Rare 140 °F	Med 160 °F	Rare 140 °F	Med 160 °F
Weight (pounds)	Phase 1 Cooking Time (minutes)					
8	165	225	105	135	90	105
9	180	240	120	150	90	120
10	195	270	135	165	105	120
11	210	285	135	180	105	135
12	225	315	150	195	105	150
13	240	330	165	210	120	150
14	255	360	165	225	120	165
15	270	375	180	225	135	165
16	285	390	180	240	135	180
17	300	405	195	255	150	180
18	300	420	210	270	150	195
19	315	450	210	270	165	210
20	330	465	225	285	165	210
21	345	480	225	300	180	225
22	360	495	240	300	180	225
23	375	510	240	315	180	240
24	375	540	255	330	195	240
25	390	555	270	345	195	255
26	405	570	270	345	210	270
27	420	585	270	360	210	270
28	435	600	285	375	210	270
29	450	615	300	390	225	285
30	450	630	300	390	225	285
	Allow additional time (minutes) for the oven temperature to decline to the Hold Temperature (140 °F)					
	60 minutes		90 minutes		120 minutes	

Cook And Hold — Standing Rib Roast – Refrigerated, Not Frozen						
Oven Temp °F	200 °F		250 °F		300 °F	
Doneness Final Internal Temp °F	Rare 140 °F	Med 160 °F	Rare 140 °F	Med 160 °F	Rare 140 °F	Med 160 °F
Weight (pounds)	Phase 1 Cooking Time (minutes)					
8	135	195	90	120	75	90
9	150	210	90	120	75	90
10	150	210	105	135	75	90
11	165	225	105	135	90	105
12	165	240	105	150	90	105
13	180	240	120	150	90	105
14	180	255	120	150	90	105
15	180	255	120	165	90	120
16	195	270	120	165	105	120
17	195	285	135	165	105	120
18	210	285	135	180	105	120
19	210	300	135	180	105	135
20	210	300	150	180	105	135
21	225	300	150	195	105	135
22	225	315	150	195	120	150
23	240	330	150	195	120	150
24	240	330	165	210	120	150
25	240	330	165	210	120	150
26	240	345	165	210	120	150
27	255	345	165	210	120	165
28	255	360	180	225	120	165
29	270	360	180	225	135	165
30	270	360	180	225	135	165
	Allow additional time (minutes) for the oven temperature to decline to the Hold Temperature (140 °F)					
	60 minutes		90 minutes		120 minutes	

Cook And Hold — Other Foods						
	Quantity	Size	Oven Temp °F	Time (minutes)		Final Internal Temp °F
				Phase 1 Cook	Hold Additional	
Leg of Lamb	1 or more of same size	5 - 15 lb each	300	20 min / lb	5 min / lb	180
Smoked Ham, fully cooked	1 or more of same size	15 lb each	300	120 min	150 min	155
Chicken	1 - 12 of same size	2 - 3 lb each	300	30 min	10 min	180
	18 - 24 of same size	2 - 3 lb each		40 min	15 min	
Duckling	1 - 5 of same size	3.5 - 4 lb each	325	55 min	15 min	200
	6 - 10 of same size	3.5 - 4 lb each		70 min	25 min	
Turkey	1 or more of same size	12 lb each	250	125 min	55 min	190
		14 lb each		150 min		
		16 lb each		175 min		
		18 lb each		200 min		
		20 lb each		220 min		
22 lb each	240 min					
White Potatoes, baked, in jackets	up to 50 pounds	120 count	400	30 min	15 min	200
	60 - 75 pounds			40 min		
	80 - 100 pounds			50 min		
	up to 50 pounds	80 count	400	40 min	15 min	200
	60 - 75 pounds			50 min		
80 - 100 pounds	60 min					







EXAMPLE PROGRAM









This example shows how to program a three-phase process for cooking Roast Beef, 18 pounds per roast, and store it as program number 20.







The second item in the table on page 21 provides most of the information: For Combi time, Phase 2, 15 minutes-per-pound times 18 pounds-per-roast equals 270 minutes (or 4 hours and 30 minutes). We assumed that Steam Factor at 20 would be OK. We chose the average temperature when a temperature range was given. We chose to leave the Vent Closed during phase 3. In this example, we will not use the temperature probe. Refer to the menu card example at the bottom of page 25.

Phase 1	Phase 2	Phase 3
STEAM Mode 212 °F 20 minutes	COMBI Mode - Steam Factor = 20 295 °F 4 hours and 30 minutes	HOT AIR Mode - Vent Closed 375 °F 10 minutes





Turn the oven ON.

Phase 1 Select Steam Mode by pressing . The first light blinks on the phase button  to indicate you are programming Phase 1. Press : The Temperature displays 212°F and needs no adjustment. Press  and press  to increase or  to decrease until the Time displays [- h 20 min]. Press  to shift to Phase 2: The second indicator light begins to flash.

Phase 2 Select Combi Mode - Steam Factor of 20 by pressing  3 times. The first three indicator lights will be lit indicating Steam Factor equals 20. Press  and press  to increase or  to decrease until the Temperature displays 295°F. Press  and press  to increase or  to decrease until the Time displays [4 h 30 min]. Press  to shift to Phase 3: The third indicator light begins to flash.

Phase 3 Select Convection (HOT AIR) Mode by pressing  once (Vent is Closed). Press  and press  to increase or  to decrease until the Temperature displays 375°F. Press  and press  to increase or  to decrease until the Time displays [- h 10 min].

Press  twice.

Save Press the  key and press  to increase or  to decrease until the Program Number displays . Verify that this program number is vacant, or choose a different program number that is vacant. A vacant program displays the current temperature, blank Time [- h - - min], and no Mode or Phase indicator lights are lit. Then press  until the beep is heard and the program is saved in memory.

MENU CARD

PROGRAM NUMBER _____		Prep.					
Menu Item _____							
	MODE Hot Air - Vent (Closed / Open) Steam - Combi - (Steam Factor 1•, 2•, 3•, 4•, 5•, 6•)	FINISH		OVEN CONTROL			
		TIME Hr. Min.	PROBE °F	TEMP. °F	 F°	FAN Speed Full or 1/2	HUMIDIFIER Manual
Phase 1							
Phase 2							
Phase 3							
Phase 4							
Phase 5							

PROGRAM NUMBER 20		Prep. 18 pounds each - refrigerated at 40°F -					
Menu Item ROAST BEEF		set at room temperature 1 hour before roasting					
	MODE Hot Air - Vent (Closed / Open) Steam - Combi - (Steam Factor 1•, 2•, 3•, 4•, 5•, 6•)	FINISH		OVEN CONTROL			
		TIME Hr. Min.	PROBE °F	TEMP. °F	 F°	FAN Speed Full or 1/2	HUMIDIFIER Manual
Phase 1	STEAM	20 Min.		212°F		Full	No
Phase 2	COMBI - 3• ~ Steam Factor = 20	4Hr. 30Min.		295°F		Full	No
Phase 3	HOT AIR - Vent Closed	10 Min.		375°F		Full	No
Phase 4							
Phase 5							

PROGRAM NUMBER _____							
Menu Item _____							
	MODE Hot Air - Vent (Closed / Open) Steam - Combi - (Steam Factor	FINISH		OVEN CONTROL			
		TIME Hr. Min.	PROBE °F	TEMP. °F	 F°	FAN Speed Full or 1/2	HUMIDIFIER Manual
Phase 1							
Phase 2							
Phase 3							
Phase 4							
Phase 5							

PROGRAM NUMBER _____		Prep.					
Menu Item _____							
	MODE Hot Air - Vent (Closed / Open) Steam - Combi - (Steam Factor 1•, 2•, 3•, 4•, 5•, 6•)	FINISH		OVEN CONTROL			
		TIME Hr. Min.	PROBE °F	TEMP. °F	 F°	FAN Speed Full or 1/2	HUMIDIFIER Manual
Phase 1							
Phase 2							
Phase 3							
Phase 4							
Phase 5							

PROGRAM NUMBER _____		Prep.					
Menu Item _____							
	MODE Hot Air - Vent (Closed / Open) Steam - Combi - (Steam Factor 1•, 2•, 3•, 4•, 5•, 6•)	FINISH		OVEN CONTROL			
		TIME Hr. Min.	PROBE °F	TEMP. °F	F°	FAN Speed Full or 1/2	HUMIDIFIER Manual
Phase 1							
Phase 2							
Phase 3							
Phase 4							
Phase 5							

PROGRAM NUMBER _____		Prep.					
Menu Item _____							
	MODE Hot Air - Vent (Closed / Open) Steam - Combi - (Steam Factor 1•, 2•, 3•, 4•, 5•, 6•)	FINISH		OVEN CONTROL			
		TIME Hr. Min.	PROBE °F	TEMP. °F	F°	FAN Speed Full or 1/2	HUMIDIFIER Manual
Phase 1							
Phase 2							
Phase 3							
Phase 4							
Phase 5							

DELUXE MANUAL CONTROL

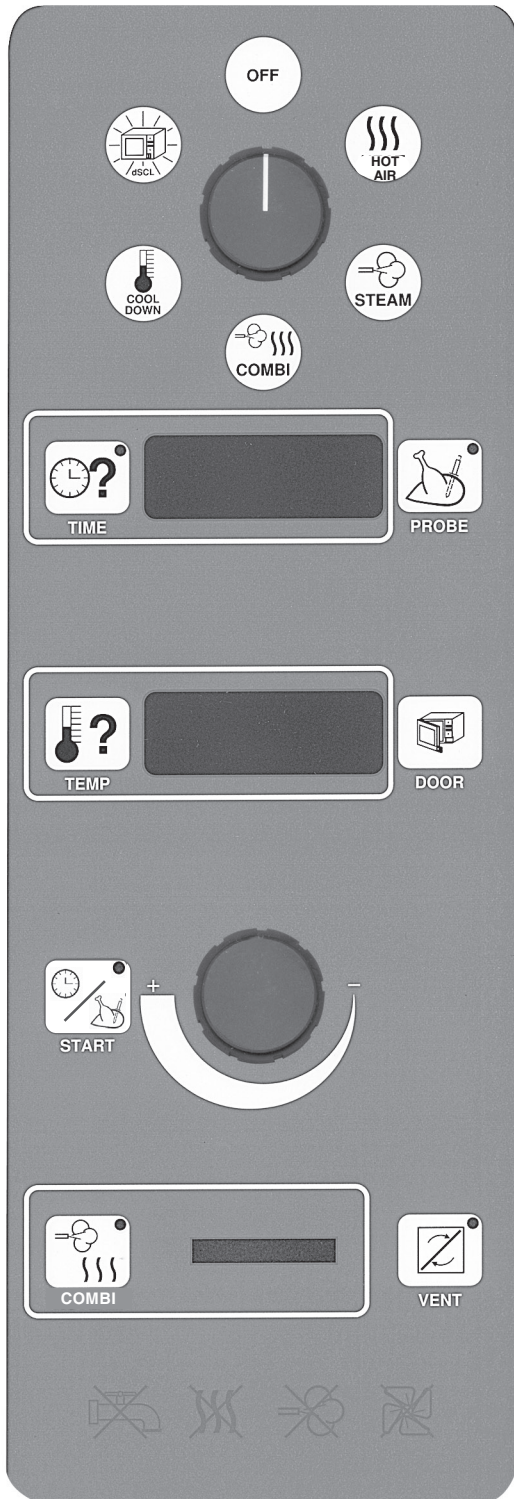

SELECTOR SWITCH

- OFF
- CONVECTION HOT AIR MODE (Temp.Range 35 – 518°F)
- STEAM MODE (Temp.Range 35 – 212°F)
- COMBI MODE (Temp.Range 35 – 518°F)

NOTE: Changing from Hot Air or Combi Modes to Steam Mode will discharge the Humidifier and lower the temperature to 212°F.

- COOL DOWN — Door opens to latched position and fan is on until the set temperature is reached. Fan will come on if thermostat setting is below the actual temperature.
- dSCL, Clean Cycle Deliming (page 34)

COOKING TIME or PROBE TEMPERATURE

- SELECT Cooking Time
- DISPLAY Cooking Time Remaining. Press TIME for three seconds to momentarily display the original TIME setting.
- SELECT Probe Temperature, final (Temp. Range 70 - 210°F)
- DISPLAY Probe Temperature, actual

OVEN TEMPERATURE

- SELECT Oven Temperature
- DISPLAY Oven Temperature Setting. Press TEMP for three seconds to momentarily display the actual Oven Temperature.

DOOR OPEN

START

- START Timer Countdown
- START Probe Cooking Operation

KNOB

- SET Oven Temperature
- SET Probe Temperature
- SET Timer

STEAM FACTOR 1 – 6 Indicator Lights (page 20)

VENT Open or Closed

Trouble Indicator Lights:

Water Supply / Heat / Steam / Fan

ENTERING A MANUAL COOKING OPERATION — Deluxe Control

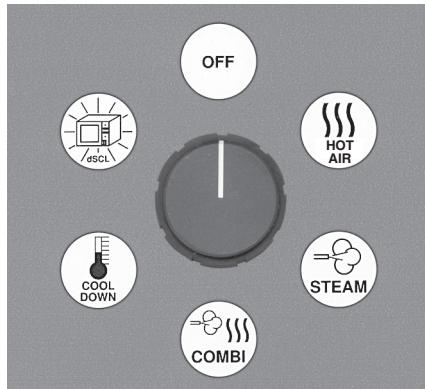

1. When setting cooking parameters, always select the **Mode** as the first element in the cooking operation: HOT AIR, STEAM, or COMBI. The previous temperature setting used in that Mode is displayed. For Combi Mode, the previous Steam Factor setting is also displayed. After selecting the Mode, the oven begins to heat and maintains the set temperature unless adjusted.

- In Combi Mode, select the Steam Factor by pressing





- 1 to 6 times to obtain the desired steaming.

Refer to the table at the bottom of page 20.

- Select Vent Open or Closed. If the Indicator Light is lit, the vent is open.

2. Enter the finish parameter for the cooking program (COOKING TIME or PROBE TEMP.) with its value.

- Press  and set the Cooking Time using the knob to adjust so the correct value is displayed.

- Or, press  and set the final Probe Temperature for the product being cooked using the knob to adjust so the correct value is displayed. Refer to the Final Probe Temperature Table on page 13.

3. Press . The previous Oven Temperature setting displays. Use the Knob to adjust the Oven Temperature setting so the correct value is displayed.

4. Press START to start timer countdown or probe cooking. Colon flashes during countdown.

5. When finished, the buzzer sounds. Press START to silence the buzzer; the Time display will automatically reset to the initial value. The heating elements continue to maintain the Oven Temperature at the set value.

6. Press  to open the door to the latched but slightly

open position for three seconds. Manually disengage the latch by turning the handle 90 degrees and pulling the door open within the three second interval. If the door is not manually disengaged within the three second interval, the door automatically re-closes.

NOTE: After pressing the selection button (TIME or TEMP), the display will start flashing. While rotating the Knob, the display remains constant. At end of adjustment, the set value flashes for 5 seconds and then displays without flashing.

STANDARD MANUAL CONTROL

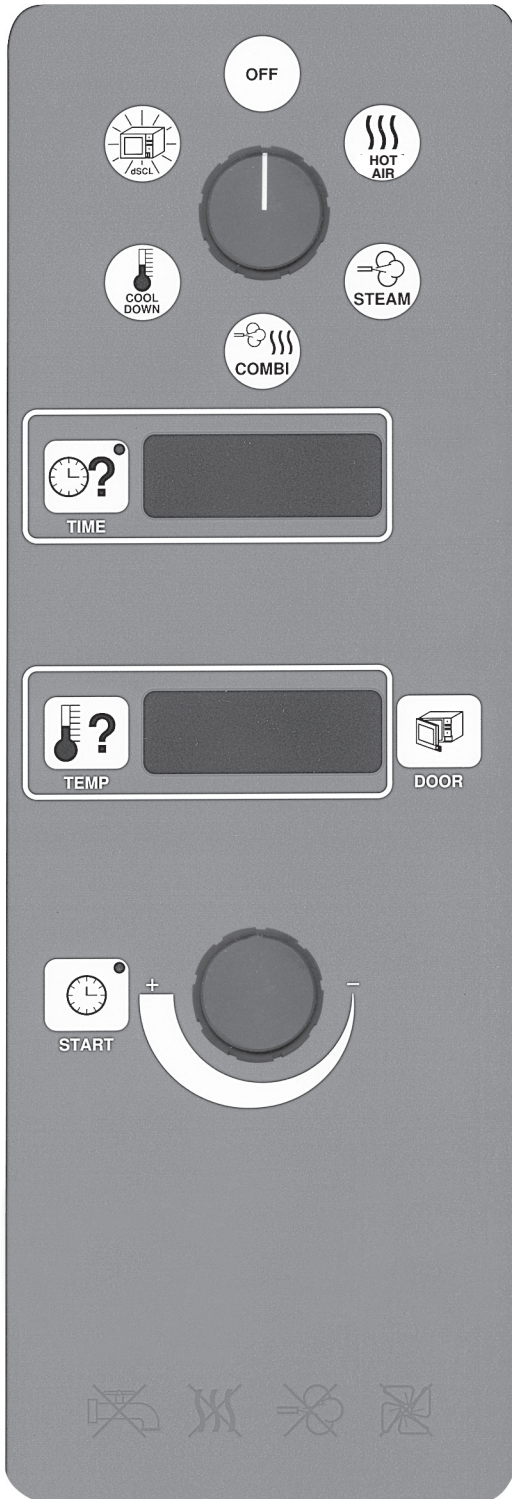

SELECTOR SWITCH

- OFF
- CONVECTION HOT AIR MODE (Temp.Range: 35–518°F)
- STEAM MODE (Temp.Range: 35 – 212°F)
- COMBI MODE (Temp.Range: 35 – 518°F)

NOTE: Changing from Hot Air or Combi Modes to Steam Mode will discharge the Humidifier and lower the temperature to 212°F.

- COOL DOWN — Door opens to latched position and fan is on until the set temperature is reached. Fan will come on if thermostat setting is below the actual temperature.
- dSCL, Clean Cycle Delimiting (page 34)

COOKING TIME

- SELECT Cooking Time
- DISPLAY Cooking Time Remaining. Press TIME for three seconds to momentarily display the original TIME setting.

OVEN TEMPERATURE

- SELECT Oven Temperature
- DISPLAY Oven Temperature Setting. Press TEMP for three seconds to momentarily display the actual Oven Temperature.

DOOR OPEN

START

- START Timer Countdown

KNOB

- SET Oven Temperature
- SET Timer

Trouble Indicator Lights:

Water Supply / Heat / Steam / Fan

ENTERING A MANUAL COOKING OPERATION — Standard Control

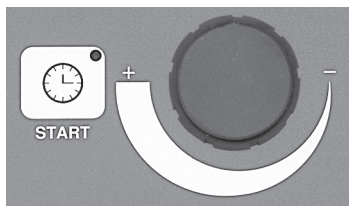
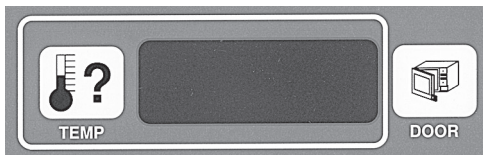
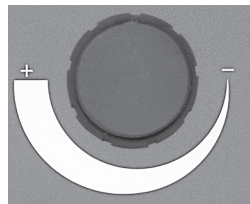
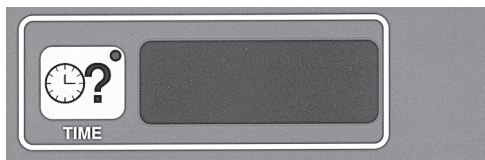
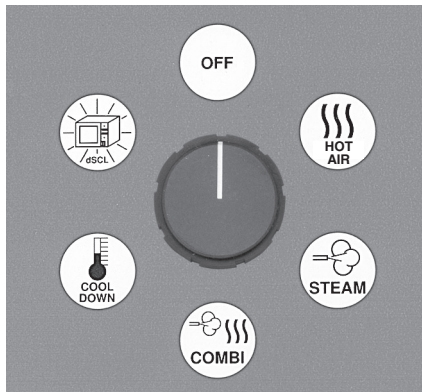

1. When setting cooking parameters, always select the **Mode** as the first element in the program: HOT AIR, STEAM, or COMBI. The previous temperature setting used in that Mode is displayed. After selecting the Mode, the oven begins to heat and maintains the set temperature unless adjusted. The Steam Factor in Combi Mode is automatically fixed on 20 and cannot be adjusted (this is the same as if three indicator lights were lit — see table at bottom of page 20).

2. Press  and set the Cooking Time using the knob to adjust so the correct value is displayed.

NOTE: After pressing the selection button (TIME or TEMP), the display will start flashing. While rotating the Knob, the display remains constant. At end of adjustment, the set value flashes for 5 seconds and then displays without flashing.

3. Press . The previous Oven Temperature setting displays. Use the Knob to adjust the Oven Temperature setting so the correct value is displayed.

4. Press START to start timer countdown. Colon flashes during countdown.

5. When finished, the buzzer sounds. Press START to silence the buzzer; the Time display will automatically reset to the initial value. The heating elements continue to maintain the Oven Temperature at the set value.

6. Press  to open the door to the latched but slightly open position for three seconds. Manually disengage the latch by turning the handle 90 degrees and pulling the door open within the three second interval. If the door is not manually disengaged within the three second interval, the door automatically re-closes.

CLEANING

Daily Cleaning

Preheat the oven to 130°F and spray a mild detergent solution that does not contain chlorine on the inside surfaces of the oven. A Spray Bottle is provided. Allow the detergent solution to react for 15 minutes.

Operate the oven on Steam mode for 15 minutes. Allow the oven to cool; wipe the oven interior with a sponge and warm water. Dry the oven interior with a clean soft cloth.

DO NOT use abrasive products.

Clean the exterior with a cloth or sponge and non-aggressive, non-abrasive products.

Complete Cleaning

WARNING: DISCONNECT THE ELECTRICAL POWER SUPPLY FROM THE OVEN AND FOLLOW LOCKOUT / TAGOUT PROCEDURES.

Remove the rack (Fig. 8). Remove the grease filter (Fig. 8) at the rear of the oven chamber by lifting up and out. Remove the fan baffle (Fig. 9) by lifting up and out. Remove the rack retainer (Fig. 9) normally located under the grease filter and fan baffle. Wash the removed parts in a sink with warm soapy water, rinse with clear water, and dry with a clean dry cloth.

Clean all areas of the oven and all parts. Reinstall the parts in their original positions.

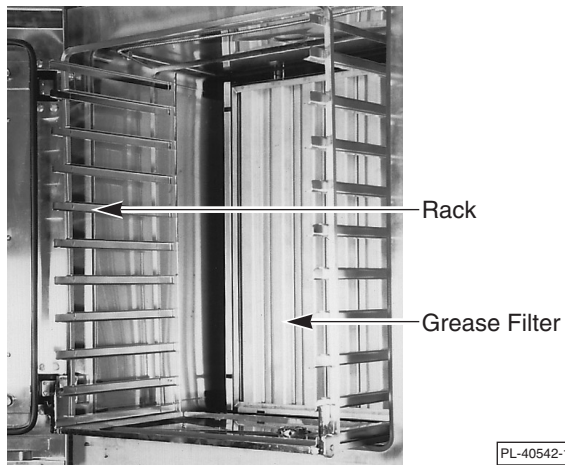

Fig. 8

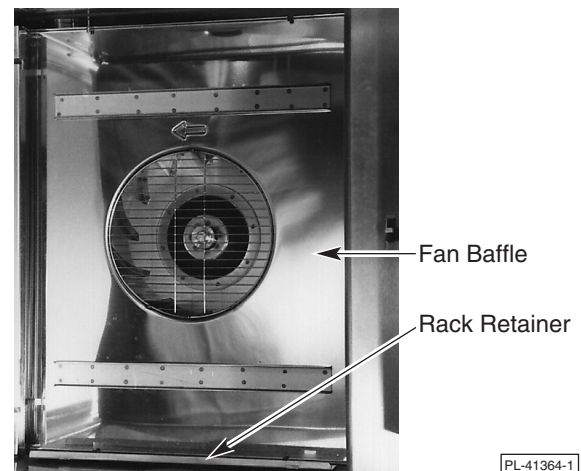

Fig. 9

If using the hose spray accessory to clean the oven interior, DISCONNECT ELECTRICAL POWER and avoid spraying near the controls.

DO NOT use steel wool or abrasive scouring pads as they will scratch and ruin the oven surfaces.

Sanitize the temperature probe. Return it to its home position in the bracket on the ceiling of the oven.

Complete Cleaning (continued)

The interior glass door (Fig. 10) is independently hinged to allow both sides of the glass doors to be cleaned. With the oven door open, pull the interior glass door away from the exterior oven door. The snap-release fasteners should allow the interior glass door to swing free. All four sides of the glass can be cleaned using a cloth and glass cleaner or warm soapy water and a clear water rinse. The area between, behind, and around the surfaces of the upper and lower hinges can be cleaned by holding both ends of a moist soapy cleaning cloth folded in a three inch wide strip and swabbing up and down; rinse and dry with clean wet or dry cloth in the same manner. When glass is clean, push the interior glass door against the exterior oven door and the snap-release fasteners should re-fasten the interior glass door to the exterior glass door so it operates as one door.

Wipe surfaces which touch the door gasket with a cloth or sponge and warm soapy water, rinse with warm clear water, and wipe with a dry cloth. **CAUTION: Do not allow the door gasket to come in contact with food oils, petroleum solvents, lubricants, or caustic cleaners.**

For 6 and 10 level ovens, remove the condensate gutter (Fig. 10) by removing the two thumb screws that attach it to the bottom of the inside of the door frame. For 20 level ovens, the three segment condensate gutter may be removed for cleaning. Save the screws. Wash and rinse the condensate gutter in a sink with warm soapy water and a clear water rinse, and dry with a clean dry cloth. To reinstall condensate gutter: Reverse the removal procedure, align screw holes and tighten screws.

Keep the cooking compartment drain (Fig. 10) working freely. After cooking grease producing foods, operate the oven with the compartment empty for 30 minutes at the end of the day, or slowly pour $\frac{1}{2}$ gallon of warm soapy water down the drain, followed by $\frac{1}{2}$ gallon of warm clear water. The drain grating may be removed for cleaning; replace it in its original position when done.

Leave the door slightly open when the oven is not in use to allow the inside to dry out.

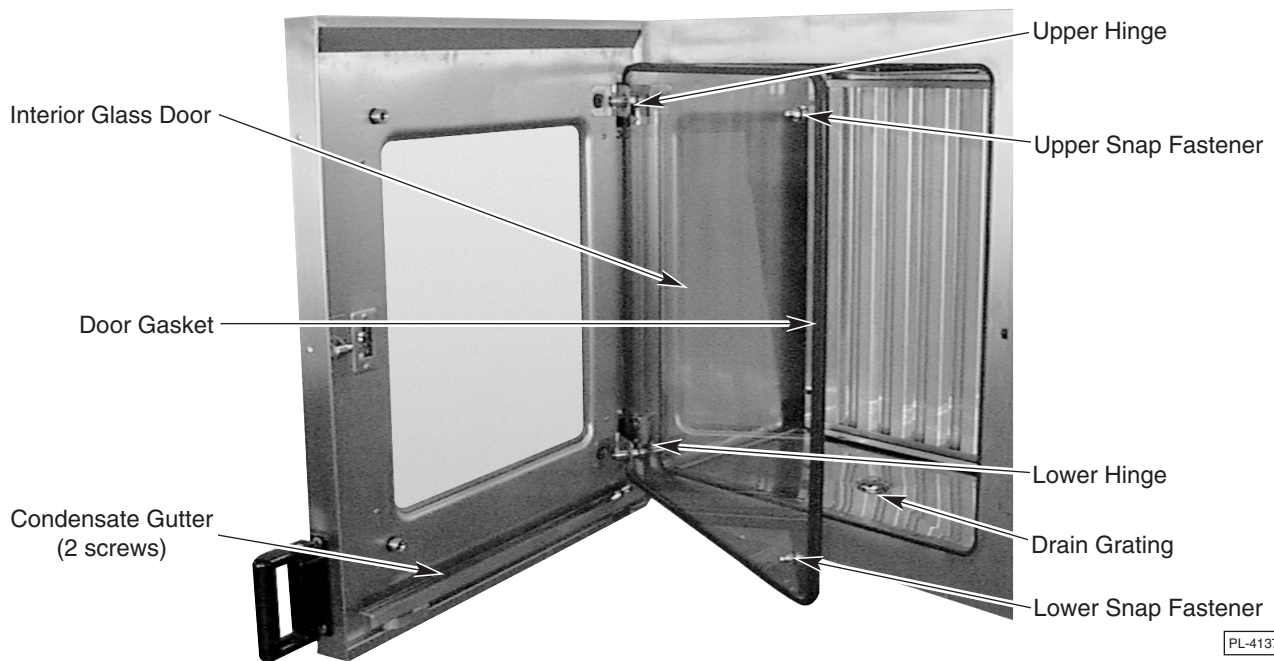



Fig. 10

MAINTENANCE

WARNING: THE OVEN AND ITS PARTS ARE HOT. USE CARE WHEN OPERATING, CLEANING OR SERVICING THE OVEN. THE COOKING COMPARTMENT CONTAINS LIVE STEAM. STAY CLEAR WHEN OPENING DOOR.

CLEAN CYCLE DELIMING PROCEDURE

- With the Programmable Control, select the Clean Cycle [Program Number 00 and  or Program Number 98 and . [CC] will display as the Program Number, [dSCL] will display in the Temperature Display. Push Start Stop. The indicator light in the Start Stop key will light. For Manual Controls, turn the Selector Switch to dSCL.
1. The Steam Generator will drain, the oven will beep for 5 seconds, and [40] will display in the Time Display and the indicator light in the Start Stop key will turn off.
 2. If the filter system is installed in the water line to the steam generator, remove the cartridge from the housing, install the dip tube and add the appropriate amount of ScaleKleen descaling chemicals for the Combi Model as specified in Column D or E of the following table.
 - If there is no filter system installed in the water line to the steam generator, add the amount of vinegar equal to the Tank Volume as specified in Column B or C of the following table. Add the vinegar to the steam generator tank through the opening inside the oven cavity using the funnel and flexible tube provided with the oven.

CLEAN CYCLE DELIMING — TANK VOLUME AND CHEMICAL REQUIREMENTS

DO NOT EXCEED THE RECOMMENDED CHEMICAL CONCENTRATION

A. MODEL	B. TANK VOLUME U.S.GALLONS	C. TANK VOLUME (QUARTS)	D. QUANTITY OF 7 oz. PACKETS OF SCALEKLEEN TO ACHIEVE 7 oz / gallon	E. QUANTITY OF 2.2 lb. PACKETS OF SCALEKLEEN TO ACHIEVE 2.2 lb / five gallons
VCE6H	0.8 gal.	3.2 qts.	0.8 packets or 5.6 oz.	0.16 packets or 5.6 oz.
VCE10H	1.6 gal.	6.3 qts.	1.5 packets or 10.5 oz.	0.3 packets or 10.5 oz.
VCE10F	1.6 gal.	6.3 qts.	1.5 packets or 10.5 oz.	0.3 packets or 10.5 oz.
VCE20H	2.6 gal.	10.5 qts.	2.5 packets or 17.5 oz.	0.5 packets or 17.5 oz.
VCE20F	3.4 gal.	13.7 qts.	3.4 packets or 24.0 oz.	0.7 packets or 24.0 oz.

3. Press the START button. The door closes and locks and the control cannot be interrupted until the Clean Cycle is finished. The oven cannot be turned off. If a power interruption occurs, the Clean Cycle will resume after power is restored. No other operations can be performed until the Clean Cycle is 'DONE'.

- If the cavity temperature is above 212°F, automatic Cool Down will occur. During automatic Cool Down, the Time Display will show the rain symbol instead of time.

The timer will start counting down.

The steam generator will fill with water until the water level controls shut off the fill.

The steam generator heater elements will produce steam for 30 minutes.

After 30 minutes, the steam generator tank will drain.

The Time Display will show 10 minutes. The timer will not count down.

The Steam Generator will fill and drain two times. The fill time is programmed for each model.

The Time Display will begin counting down, the Steam Generator heaters are ON with steam being generated.

At the end of the ten minute interval, the Steam Generator tank will drain.

'DONE' will display in the Temperature Display indicating that the Clean Cycle is complete.

NOTE: If an error occurs during the Clean Cycle, 'FAIL' will display in the Temperature Display instead of 'DONE'.

Per the instructions in the filter cartridge replacement and preventive maintenance kit: Retest the water, return the response card and replace the filter cartridge.

CONFIGURATION MODE — PROGRAMMABLE CONTROL

WARNING: DISCONNECT THE ELECTRICAL POWER SUPPLY FROM THE OVEN AND PLACE A TAG AT THE DISCONNECT SWITCH INDICATING THAT THE CIRCUIT IS BEING WORKED ON.

Identify the manufacturer(s) of the convection fan motor(s) by inspecting the label on the motor(s) after the rear panel is removed. This information is needed for Steps 9 – 11. Replace rear panel and reconnect electrical power.

Some of the procedures in this section are set at the factory and do not need to be re-valued. Only steps 2, 6, and 7 must be completed at time of installation. Other values, if changed improperly, could result in the oven not operating properly and may require a service technician.

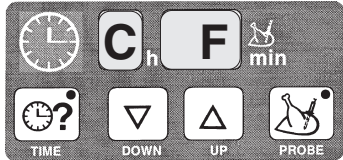







1. Configuration Mode can be entered only when the oven is OFF. With the oven OFF, press  and the UP and DOWN arrows in the TIME area all at the same time for about three seconds. [Conf] will be displayed in the temperature display to indicate Configuration Mode.

Press  to begin.

Pressing  repeatedly advances through each step 1 through 12 and then repeats from step 2.

After any keystroke where an individual setting is either changed or accepted, the setting will display for three seconds and then automatically advances to the next step.

2. [C F] will be displayed in the TIME display to allow selection of the temperature scale. Press the UP arrow key for Fahrenheit. The DOWN arrow key is used for Celsius. A blinking F indicates Fahrenheit is selected while a blinking C would indicate Celsius. After making a selection, the selection displays for three seconds and automatically advances to the next step. Or, press  to advance to the next step.
3. [dSC] is displayed in the TIME display and the number of clean cycles completed is displayed in the TEMPERATURE display. This number cannot be changed or modified. Press  to advance to the next step.
4. The revision level of the control's software is displayed in the time display and cannot be changed. This information is needed by your service technician. Press  to advance to the next step.
5. [HHH] is displayed in the TIME display and the total cooking hours of the oven is displayed in the temperature display. This can be reset. Using the UP arrow key in the temperature display will increase the number of hours; using the DOWN arrow key will decrease the number of hours. Press  to advance to the next step.
6. [bbb] is displayed in the TIME display and the buzzer is sounding to indicate the buzzer's "on-off" frequency selection. The numeric value [000 to 255] in the TEMPERATURE display indicates the type of sound the buzzer will make. [000] makes a continuous sound while [255] beeps at a very slow interval. A good setting to start with is [050]. Press the UP or DOWN arrow keys in the temperature area to increase or decrease the numeric value to obtain the desired sound. Buzzer loudness can be adjusted by your service technician. Press  to advance to the next step.

7. [uuu] is displayed in the TIME display and the maximum steam generator temperature setting is displayed in the TEMPERATURE display. This value can be adjusted depending on the elevation (see Elevation vs. Boiling Temperature Table, below). Press the UP or DOWN arrow keys in the temperature area to increase or decrease the numeric value. Press  to advance to the next step.

ELEVATION	Sea Level to 500 Ft.	500 to 1000 Ft.	1000 to 2000 Ft.	2000 to 3000 Ft.	3000 to 4000 Ft.	4000 to 5000 Ft.	5000 to 6000 Ft.	6000 to 7000 Ft.	7000 to 8000 Ft.	8000 to 9000 Ft.	9000 to 10,000 Ft.	Above 10,000 Ft.
BOILING TEMPERATURE (WATER) ° F	212° F	211° F	209° F	207° F	205° F	204° F	202° F	200° F	198° F	196° F	195° F	194° F

8. [CCC] is displayed in the TIME display and the maximum convection oven temperature setting is displayed in the TEMPERATURE display. This value can be adjusted from 482°F to 518°F. It is recommended the [CCC] setting be 518°F. Press the UP or DOWN arrow keys in the temperature area to increase or decrease the numeric value. Press  to advance to the next step.



9. Set the Minimum and Maximum Values in steps 10 and 11 according to the FAN MOTOR COEFFICIENTS TABLE, below, the motor manufacturer's label, and the number of convection fan motors in the oven.

FAN MOTOR COEFFICIENTS TABLE

Motor Manufacturer(s)	Number of Convection Fan Motors	Minimum Value 1 - - See step 10.	Maximum Value 2 - - See step 11.
Leroy-Somer (Hanning)	1	10	55
Brook-Crompton	1	08	60
Both motors by Leroy-Somer (Hanning)	2	42	130
Both motors by Brook-Crompton	2	26	72
1 motor by Leroy-Somer (Hanning) and 1 motor by Brook-Crompton	2	10	55

10. [1 - -] is displayed in the TIME display and the Minimum Value is displayed in the TEMPERATURE display. Press the UP and DOWN arrow keys in the temperature area to increase or decrease the Minimum Value according to the table above. Press  to advance to the next step.

11. [2 - -] is displayed in the TIME display and the Maximum Value is displayed in the TEMPERATURE display. Press the UP and DOWN arrow keys in the temperature area to increase or decrease the Maximum Value according to the table above. Press  to advance to the next step.

12. To repeat the Configuration Mode process from step 1, press . To exit Configuration Mode and save all settings, press .

CONFIGURATION MODE — MANUAL CONTROL (Standard or Deluxe)









WARNING: DISCONNECT THE ELECTRICAL POWER SUPPLY FROM THE OVEN AND FOLLOW LOCKOUT / TAGOUT PROCEDURES.

Identify the manufacturer(s) of the convection fan motor(s) by inspecting the label on the motor(s) after the rear panel is removed. This information is needed for Steps 8 – 10. Replace rear panel and reconnect electrical power.

Some of the procedures in this section are set at the factory and do not need to be re-valued. Only steps 2, 6, and 7 must be completed at time of installation. Other values, if changed improperly, could result in the oven not operating properly and may require a service technician.

Pressing  TIME repeatedly advances through each step 1 through 12 and then repeats from step 2.

After any keystroke where an individual setting is either changed or accepted, the setting will display for three seconds and then automatically advances to the next step.

1. Configuration Mode can be entered only when the oven is OFF. With the oven OFF, press  and  at the same time for about three seconds. [Conf] will be displayed in the temperature display to indicate Configuration Mode. Press  TIME to begin.
2. [C F] will be displayed in the TIME display to allow selection of the temperature scale. Turn the adjustment knob clockwise for Fahrenheit; turning counterclockwise would select Celsius. A blinking F indicates Fahrenheit is selected while a blinking C would indicate Celsius. After making a selection, the selection displays for three seconds and automatically advances to the next step. Or, press  TIME to advance to the next step.
3. [dSCL] is displayed in the TIME display and the number of clean cycles completed is displayed in the TEMPERATURE display. This number cannot be changed or modified. Press  TIME to advance to the next step.
4. The revision level of the control's software is displayed in the time display and cannot be changed. This information is needed by your service technician. Press  TIME to advance to the next step.
5. [HHHH] is displayed in the TIME display and the total cooking hours of the oven is displayed in the temperature display. This can be reset. Rotate the knob counterclockwise to decrease the number of hours; rotate the knob clockwise to increase the number of hours. Press  TIME to advance to the next step.
6. [bbbb] is displayed in the TIME display and the buzzer is sounding to indicate the buzzer's "on-off" frequency selection. The numeric value [000 to 255] in the TEMPERATURE display indicates the type of sound the buzzer will make. [000] makes a continuous sound while [255] beeps at a very slow interval. A good setting to start with is [050]. Rotate the knob counterclockwise to decrease buzzer frequency; rotate the knob clockwise to increase buzzer frequency. Buzzer loudness can be adjusted by your service technician. Press  TIME to advance to the next step.



7. [uuuu] is displayed in the TIME display and the maximum steam generator temperature setting is displayed in the TEMPERATURE display. This value must be adjusted for the elevation (see Elevation vs. Boiling Temperature Table, below). Rotate the adjustment knob clockwise to increase or counterclockwise to decrease the numeric value. Press  TIME to advance to the next step.

ELEVATION	Sea Level to 500 Ft.	500 to 1000 Ft.	1000 to 2000 Ft.	2000 to 3000 Ft.	3000 to 4000 Ft.	4000 to 5000 Ft.	5000 to 6000 Ft.	6000 to 7000 Ft.	7000 to 8000 Ft.	8000 to 9000 Ft.	9000 to 10,000 Ft.	Above 10,000 Ft.
BOILING TEMPERATURE (WATER) ° F	212° F	211° F	209° F	207° F	205° F	204° F	202° F	200° F	198° F	196° F	195° F	194° F

8. [CCCC] is displayed in the TIME display and the maximum convection oven temperature setting is displayed in the TEMPERATURE display. This value can be adjusted from 482°F to 518°F. It is recommended the [CCCC] setting be 518°F. Rotate the adjustment knob counterclockwise to decrease or clockwise to increase the numeric value. Press  TIME to advance to the next step.
9. Set the Minimum and Maximum Values in steps 10 and 11 according to the FAN MOTOR COEFFICIENTS TABLE, below, the motor manufacturer's label, and the number of convection fan motors in the oven.

FAN MOTOR COEFFICIENTS TABLE

Motor Manufacturer(s)	Number of Convection Fan Motors	Minimum Value 1 - - See step 10.	Maximum Value 2 - - See step 11.
Leroy-Somer (Hanning)	1	10	55
Brook-Crompton	1	08	60
Both motors by Leroy-Somer (Hanning)	2	42	130
Both motors by Brook-Crompton	2	26	72
1 motor by Leroy-Somer (Hanning) and 1 motor by Brook-Crompton	2	10	55

10. [1 - -] is displayed in the TIME display and the Minimum Value is displayed in the TEMPERATURE display. Rotate the adjustment knob clockwise to increase or counterclockwise to decrease the Minimum Value according to the table above. Press  TIME to advance to the next step.
11. [2 - -] is displayed in the TIME display and the Maximum Value is displayed in the TEMPERATURE display. Rotate the adjustment knob clockwise to increase or counterclockwise to decrease the Maximum Value according to the table above. Press  TIME to advance to the next step.
12. To repeat the Configuration Mode process from step 2, press . To exit Configuration Mode and save all settings, press the START button.

TROUBLESHOOTING



Four lights (above) on the control panel indicate oven operation is not possible. If the Water Supply valve is off and the steam generator does not have water, the Water Supply trouble indicator will light and the buzzer will sound for one minute. The Water Supply trouble indicator light will remain lit until the error is eliminated. Make sure the manual water valve is open. If the water valve was closed: Switch the oven off; open the valve; and restart the oven. If the the Water Supply trouble indicator was lit and the water valve was open, call Service. The other three lights on the control panel indicate oven operation is not possible. Do not attempt to restart the oven. Switch the oven off and call Service. **NOTE:** The oven can be used in Convection HOT AIR Mode when the Water Supply trouble indicator is lit.

Other error displays include [888C] or [888F] in the time display or [999C] in the temperature display while the probe is in use. These displays indicate that one of the temperature sensors is faulty: Call Service.

If [00] is displayed in the time display during probe temperature cooking, the Temperature Probe is faulty: Call Service.

If a prolonged power failure or an oven error occurs when food is located in the oven, the door may be opened manually. 1) Switch the oven off. 2) Pull the door handle firmly towards you while firmly pressing against the front of the oven with your other hand. This procedure is not used during normal operation. If the electric door opener fails to operate, call Service.

If the appliance cannot be started and the temperature display blinks, make sure the door is properly closed.

SERVICE ADJUSTMENTS

Buzzer loudness can be adjusted by your service technician.

SERVICE AND PARTS INFORMATION

To obtain service and parts information concerning this oven, contact the Vulcan-Hart Service Agency in your area (refer to listing supplied with this oven), or contact the Vulcan-Hart Service Department at the address or phone number shown on the front cover of this manual. Parts and service manuals are also available at WWW.VULCANHART.COM